

C1₅ / R1₅ LIFECYCLE® EXERCISE BIKES

USER MANUAL



Life Fitness

CORPORATE HEADQUARTERS

5100 North River Road
Schiller Park, Illinois 60176 • U.S.A.

www.lifefitness.com

INTERNATIONAL OFFICES

LIFE FITNESS ASIA PACIFIC LTD

Room 2610, Miramar Tower
132 Nathan Road
Tsimshatsui, Kowloon
HONG KONG

LIFE FITNESS ATLANTIC BV

LIFE FITNESS BENELUX

Bijdorpplein 25 - 31
2992 LB Barendrecht
THE NETHERLANDS

LIFE FITNESS DO BRAZIL

Av. Dr. Dib Sauaia Neto 1478
Alphaville, Barueri, SP
06465-140
BRAZIL

LIFE FITNESS VERTRIEBS GMBH

Dückerstraße 7-9/3/36
1220 Vienna
AUSTRIA

LIFE FITNESS IBERIA

Pol. Ind. Molí dels Frares. c/C, nº 12
08620 Sant Vicenç dels Horts (Barcelona)
SPAIN

LIFE FITNESS EUROPE GMBH

Siemensstraße 3
85716 Unterschleissheim
GERMANY

LIFE FITNESS ITALIA S.R.L.

Via Vittorio Veneto, 57/A
39042 Bressanone (Bolzano)
ITALY

LIFE FITNESS LATIN AMERICA and CARIBBEAN

5100 North River Road
Schiller Park, Illinois 60176
U.S.A.

LIFE FITNESS UK LTD

Queen Adelaide
Ely, Cambs CB7 4UB
UNITED KINGDOM

LIFE FITNESS JAPAN

Nippon Brunswick Bldg., #8F
5-27-7 Sendagaya
Shibuya-Ku, Tokyo
JAPAN 151-0051

Before using this product, it is essential to read this ENTIRE user manual and ALL installation instructions.

This will help in setting up the equipment quickly and in instructing others on how to use it correctly and safely.

FCC Warning - Possible Radio / Television Interference

NOTE: This equipment has been tested and found to comply with the limits for a Class B digital device, pursuant to part 15 of the FCC rules. These limits are designed to provide reasonable protection against harmful interference in a residential installation. This equipment generates, uses and can radiate radio frequency energy, and if not installed and used in accordance with the user manual, may cause harmful interference to radio communications. However, there is no guarantee that the interference will not occur in a particular installation. If this equipment does cause harmful interference to radio or television reception, which can be determined by turning the equipment off and on, the user is encouraged to try to correct the interference by one or more of the following measures:

- Reorient or relocate the receiving antenna.
- Increase the separation between the equipment and the receiver.
- Connect the equipment into an outlet on a circuit different from that to which the receiver is connected.
- Consult the dealer or an experienced radio/TV technician for help.

Class HB (Home): Domestic use. Not suitable for therapeutic purposes.



CAUTION: Any changes or modifications to this equipment could void the product warranty.

Any service, other than cleaning or user maintenance, must be performed by an authorized service representative. There are no user-serviceable parts.

TABLE OF CONTENTS

1.	Getting Started6
1.1	Important Safety Instructions6
1.2	Set-up8
	Where to Place the Exercise Bike // How to Stabilize the Exercise Bike // How to Adjust the Seat to Ensure Correct Biomechanical Positioning // How to Adjust the Pedal Straps // Starting Up the Bike	
2	The Display Console12
2.1	The Display Console Overview12
2.2	Display Console Descriptions12
2.3	The Water Bottle Holder and Reading Rack15
2.4	Heart Rate Monitoring16
3	The Workouts17
3.1	Workout Overviews17
3.2	Setting Up and Using the Workouts18
	Selecting and Using Quick Start Manual Mode // Selecting a Workout // Entering a Duration // Selecting and Adjusting the Intensity Level // Starting a Workout // Pausing a Workout // Resetting a Workout // Reviewing a Completed Workout // Using the Heart Rate Zone to Maximize Workout Benefits	
3.3	Workout Descriptions22

3.4	Using the Workouts (Chart)	.28
4	Service and Technical Data	.29
4.1	Preventative Maintenance Tips	.29
4.2	Preventative Maintenance Schedule	.30
4.3	Troubleshooting the Hand Sensors	.30
4.4	Troubleshooting the Exercise Bike	.31
4.5	How to Obtain Product Service	.33
5	Warranty Information	.34
6	Specifications	.37
6.1	Upright and Recumbent Exercise Bike Specifications	.37

© 2005 Life Fitness, a division of Brunswick Corporation. All rights reserved. Life Fitness is a registered trademark of Brunswick Corporation. Any use of these trademark, without the express written consent of Life Fitness is forbidden.

This Operation Manual describes the functions of the following products:

Life Fitness upright exercise bike:

C15

Life Fitness recumbent exercise bike:

R15

See Section 6, titled *Specifications* page in this manual for product-specific features.

Statement of Purpose: The exercise bike is a machine that simulates the movements of riding a bicycle at various speeds and levels of resistance.



Health-related injuries may result from incorrect or excessive use of exercise equipment. The manufacturer **STRONGLY** recommends seeing a physician for a complete medical exam before undertaking an exercise program, particularly if the user has a family history of high blood pressure or heart disease; or is over the age of 45; or smokes, has high cholesterol, is obese, or has not exercised regularly in the past year. The manufacturer also recommends consulting a fitness professional on the correct use of this product.

If, at any time while exercising, the user experiences faintness, dizziness, pain, or shortness of breath, he or she must stop immediately.

1 GETTING STARTED

1.1 IMPORTANT SAFETY INSTRUCTIONS



SAFETY WARNING: The safety of the product can be maintained only if it is examined regularly for damage and wear. See Preventative Maintenance section for details.

- Before using this product, it is essential to read this ENTIRE operation manual and ALL instructions. The exercise bike is intended for use solely in the manner described in this manual.
- Always follow the console instructions for proper operation.
- Close supervision is necessary when used by or near children, invalids or disabled persons.
- If an exercise bike does not function properly after it has been dropped, damaged, or even partially immersed in water, contact Customer Support Services for assistance.
- Never insert objects into any opening in the exercise bike. If an object should drop inside, carefully retrieve it. If the item is beyond reach, contact Customer Support Services.
- Never place liquids of any type directly on the unit, except in an accessory tray. Containers with lids are recommended.
- Do not use the exercise bike outdoors, near swimming pools or in areas of high humidity.
- Keep all loose clothing, shoelaces, and towels away from the exercise bike pedals.
- Keep the area around the exercise bike clear of any obstructions, including walls and furniture.
- Always be careful and exercise caution when mounting or dismounting the exercise bike. Use the handlebar whenever additional stability is required.
- Wear shoes with rubber or high-traction soles. Do not use shoes with heels, leather soles, cleats or spikes. Do not use the bike in bare feet.
- Do not tip the exercise bike on its side during operation.
- Keep hands and feet away from all moving parts.

- To ensure proper functioning of this product, do not install attachments or accessories that are not provided or recommended by Life Fitness.
- Use this product in a well-ventilated area.
- Use this product on a solid, level surface.
- Make sure that all components are fastened securely. These include the seat post, saddle, handlebars, and pedals.

SAVE THESE INSTRUCTIONS FOR FUTURE REFERENCE.

1.2 SETUP

Read the entire User Manual before setting up the exercise bike.

WHERE TO PLACE THE EXERCISE BIKE

Following all safety instructions in Section 1.1, move the bike to the location in which it will be used. See Section 6, titled Specifications, for the dimensions of the footprint. Allow a distance of four feet, or 120 centimeters, between the bike and other objects or surfaces on either side.

HOW TO STABILIZE THE EXERCISE BIKE

After placing the bike in position, check the unit's stability by attempting to rock it in all directions. Any slight rocking indicates that the unit must be leveled. Determine which foot is not resting completely on the floor. Loosen the jam nut with an open-end 17mm wrench, and rotate the stabilizing foot to lower it. Verify that the bike is stable, and repeat the adjustment as necessary until the unit no longer rocks. Lock the adjustment by tightening the jam nut against the stabilizer bar.

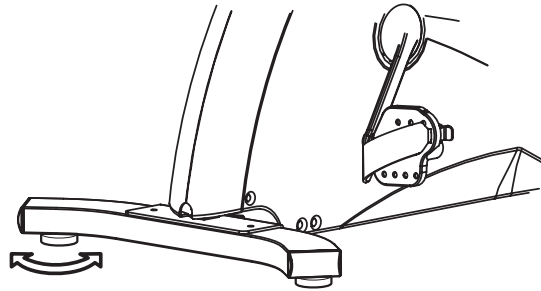

HOW TO ADJUST THE SEAT TO ENSURE CORRECT BIOMECHANICAL POSITIONING

Proper seat positioning minimizes unnecessary leg muscle fatigue. To determine whether or not the seat requires adjustment, sit on it and place the balls of the feet on the pedals. The knee should bend slightly when the pedal is at the furthest point in its rotation, relative to the body. The user should be able to pedal without locking the knees or shifting in the seat.

Adjusting the seat on the C15 upright bike: The bike post features a vertical locking pin seat adjustment system, which makes it easy and safe to change the height of the seat quickly. To raise the seat, first get off the bike. Hold the seat, turn the spring-loaded knob on the right of the seat post once counter-clockwise to loosen it, and pull out the knob to unlock the post from its present position. Pull the seat upward to the desired height, and release the knob to let it lock into place. Turn the knob once clockwise to tighten it. Test and re-adjust the seat height as necessary.

To lower the seat, first get off the bike. Hold the seat, turn the spring-loaded knob on the right of the seat post once counterclockwise to loosen it, and pull out the knob to unlock the post from its present position. Let the seat slide down to the desired height, and release the knob to let it lock into place. Turn the knob once clockwise to tighten it. Test and re-adjust the seat height as necessary.

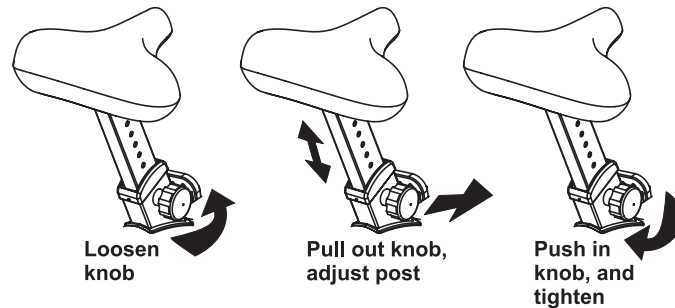

CAUTION : *When using the height adjustment mechanism to change the height of a partially raised seat, hold the seat to prevent it from falling on the hand.*

CAUTION: *Do not attempt to lock the seat at a position higher than the minimum insertion depth marked on the seat post.*

Adjusting the seat on the R15 recumbent bike: Lift the spring-loaded adjustment handle located on the right side of the seat. Slide the seat forward or backward as necessary to the proper position and release the pin to complete engagement. Gently rock the seat forward and backward to ensure that it is locked into place. Check the seat distance again and readjust it if necessary.

NOTE: *The seat carriage can be adjusted if it is too tight and does not slide freely or if it is too loose and rocks excessively.*

To adjust the fit of the carriage when there is excessive rocking use a wrench to loosen the jam nut (A) on either side of the seat carriage. With another wrench, tighten the adjustment roller on the inside of the carriage until it is snug, but do not over-tighten. Then, while holding the roller in place, tighten the lock nut. Repeat the procedure for the other side of the carriage.

To adjust the fit of the carriage when it does not slide freely, use a wrench to loosen the jam nut (A) on either side of the seat carriage. With another wrench, loosen the adjustment roller on the inside of the carriage until it can move freely, but do not excessively loosen. Then, while holding the roller in place, tighten the lock nut. Repeat the procedure for the other side of the seat carriage.

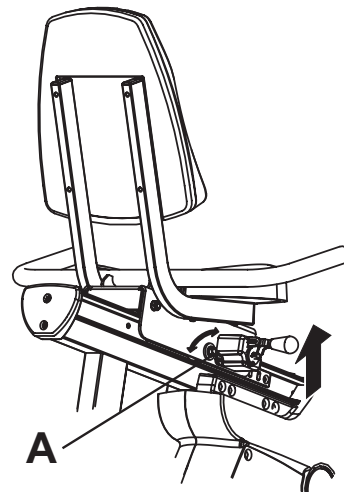

 **CAUTION:** *Do not attempt to adjust the seat while pedaling the bike. Doing so, or failing to insert the seat pin completely may result in an uncomfortable workout or cause injury.*

HOW TO ADJUST THE PEDAL STRAPS

The bike pedal safety straps keep the user's shoes on the pedals during a workout. The straps should fit comfortably, but they also should be tight enough to prevent shoes from slipping at any point in the pedaling rotation. Before working out, the user should test and adjust the tightness of the straps.

The straps can be adjusted to fit a variety of shoe sizes. Each strap is held in place by a spring-loaded clip that is connected to the outer edge of each pedal. To tighten a strap, simply pull the loose end of the strap down. It automatically locks into place with each pull. To loosen a strap, press down on the top of the clip and pull the strap up. Release the clip to lock the strap into place. Test the adjustment, and change if necessary.

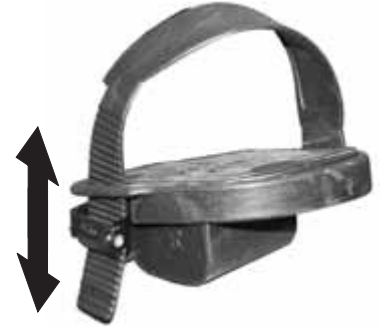

STARTING UP THE BIKE

See Section 6, titled *Specifications*, for power requirements. Insert the AC adapter into an electrical outlet that has been properly installed and grounded in accordance with all local codes and ordinances.

To power up the exercise bike, simply start pedaling or press any key on the console. Once the unit's power is on, the console display lights up, making it possible to select a workout or to begin a **MANUAL** workout using **QUICK START MANUAL MODE**. See Section 3.2, titled *Setting Up and Using the Workouts*, for more information.

2 THE DISPLAY CONSOLE

2.1 DISPLAY CONSOLE OVERVIEW

The computerized display console on the exercise bike allows the user to tailor a workout to personal fitness abilities and goals and to monitor progress. With this easy-to-use console the user can track fitness improvement from one workout to the next.

2.2 DISPLAY CONSOLE DESCRIPTIONS

The functions for the keys and display windows on the exercise bike console are listed and described in this section. See Section 3, titled *The Workouts*, for detailed information on using the console to set up workouts.

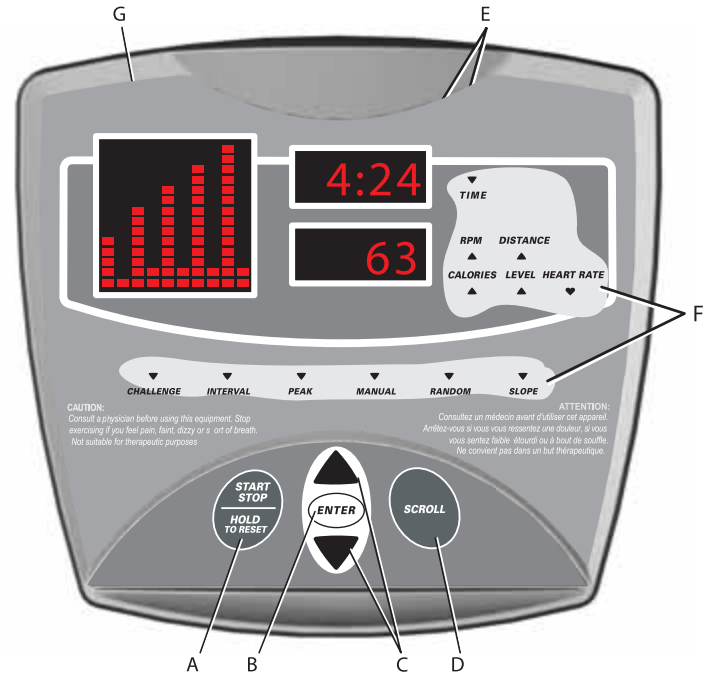

- A START/STOP/HOLD TO RESET:** Use this key to initiate a number of different functions on the bike.
- Beginning a 30-minute QUICK-START **MANUAL** workout immediately, without setup steps
 - Beginning a workout after completing the setup steps for a specific workout
 - Pausing a workout-in-progress
 - Restarting a paused workout
 - Deleting a current workout and making it possible to set up a new workout
- B ENTER:** Press this key to accept information displayed by the console when setting up a workout.
- C ARROW KEYS:** Use these keys when setting up a workout to change displayed values for workout type, duration, weight, and resistance level. When a workout is in progress, use these keys to change the intensity level.
- D SCROLL:** During a workout-in-progress, press this key to browse through workout statistics displayed in the bottom data window. Each time the SCROLL key is pressed, a different value is displayed, and its corresponding light emitting diode (LED) lights up simultaneously.

Press this key to view summary data for a completed workout, including total calories burned and total distance traveled

- E DATA WINDOWS:** Two data windows are set in the center of the console display.

The top window shows the elapsed **time** of a workout-in-progress. During a workout setup, this window also shows the default duration of 30 minutes, which the user can change using the ARROW keys.

The bottom window displays the following statistics which are represented with corresponding LED lights to the right side of the window.

2.3 THE WATER BOTTLE HOLDER AND READING RACK

A WATER BOTTLE HOLDER (A) is mounted on the monocolumn of the bike.

A READING RACK (B) for supporting a book or magazine is located at the base of the upper panel of the console.

Upright Model

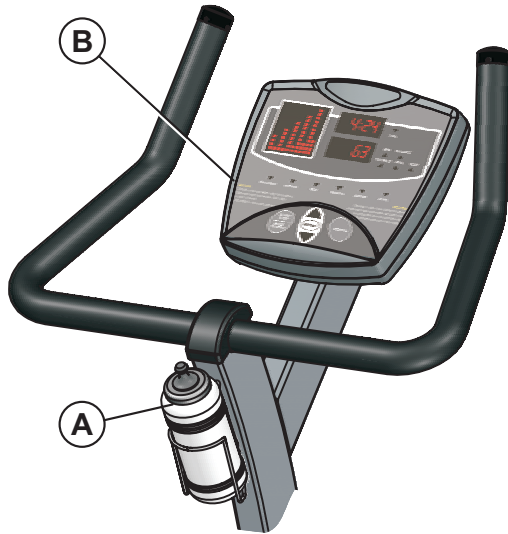

Recumbent Model

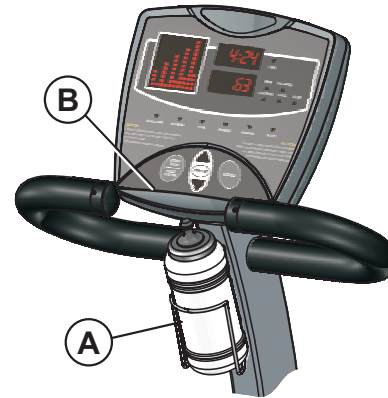

2.4 HEART RATE MONITORING

THE HAND PULSE SENSOR SYSTEM

The hand pulse sensors (A) are the built-in heart rate monitoring system on the exercise bike. During a workout, grasp the sensors that are set into the handlebars. For an accurate reading, use a comfortable grip. The console displays the heart rate after 10 to 15 seconds.

Upright Model C1₅



Recumbent Model R1₅

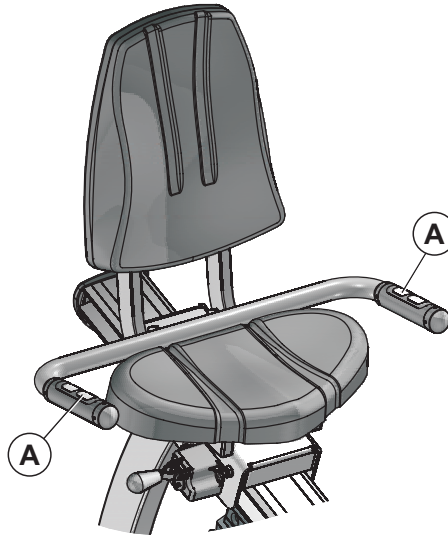

NOTE: *Excessively squeezing the hand pulse sensors will not improve the heart rate reading.*

3 THE WORKOUTS

3.1 WORKOUT OVERVIEWS

This section lists the exercise bike's pre-programmed workouts. For more detailed information, see Section 3.2, titled *Setting Up and Using the Workouts*.

QUICK START MANUAL MODE is the fastest way to begin exercising, and it bypasses the steps involved in selecting a specific workout program. After the START key is pressed, a constant-level workout begins. The resistance level does not change automatically.

INTERVAL combines "hills" and "valleys" of different resistance levels. Raising and lowering the heart rate in this manner is proven to efficiently promote fat burn and cardiovascular endurance.

RANDOM provides a completely random workout profile of "hills" and "valleys" every time the user selects this workout. Endless variety reduces boredom.

MANUAL is a workout in which the resistance level does not change automatically.

PEAK maintains a constant resistance level throughout the workout. Intended to burn fat.

SLOPE gradually increases resistance so user is less aware of the physical demand. Helps user slowly build-up to higher resistance levels and improve cardiovascular endurance.

CHALLENGE maintains a high resistance level throughout the workout. Challenges the user to a high intensity workout that promotes cardiovascular endurance.

3.2 SETTING UP AND USING THE WORKOUTS

To activate the console, press any key, or simply start pedaling. When the console display lights up, either select **QUICK START MANUAL MODE**, or select a specific workout. Setting up a specific workout involves four steps, which are described in this section:

1. Selecting a workout
2. Entering a workout duration
3. Selecting a level
4. Starting the workout (pressing START or ENTER)

SELECTING AND USING QUICK START MANUAL MODE

Press the START key to begin a 30-minute **MANUAL** workout immediately. Once the workout is in progress, it is possible to change the resistance level using the ARROW keys.

SELECTING A WORKOUT

Press the ARROW KEYS until the LED display for the desired workout lights up. Then, press ENTER to confirm the workout selection.

ENTERING A WORKOUT DURATION

After a workout is selected, the top DATA WINDOW flashes a default workout duration of 30 minutes. Press ENTER to accept the default. Or, to change the duration, use the ARROW keys. Then, when the desired duration appears in the DATA WINDOW, press ENTER to accept the duration. It is not possible to change the duration of a workout-in-progress.

SELECTING A LEVEL FOR A MANUAL WORKOUT

After a duration is entered, the bottom DATA WINDOW flashes a default difficulty level of “1”, which is the easiest of the 16 resistance levels. Press ENTER to accept the default. Or, to change the level, use the ARROW keys. Then, when the desired level appears in the DATA WINDOW, press ENTER to accept the duration. While the workout is in progress, it is possible to change the resistance level (1-16).

NOTE: *QuickStart and Manual Workouts have 1 - 16 resistance levels.*

SELECTING A LEVEL FOR RANDOM, INTERVAL, SLOPE, PEAK, AND CHALLENGE WORKOUTS

After a duration is entered, the bottom DATA WINDOW flashes a default level of “1,” which is the easiest of the 9 difficulty levels. Press ENTER to accept the default. Or, to change the level, use the ARROW keys. Then, when the desired level appears in the DATA WINDOW, press ENTER to accept the duration. While the workout is in progress, it is possible to change the difficulty level.

NOTE: *Random, Interval, Slope, Peak, and Challenge workouts have 1 - 9 levels..*

DIFFICULTY LEVEL TABLE (APPLIES TO RANDOM, INTERVAL, SLOPE, PEAK, CHALLENGE)

Program Difficulty Level	Resistance Level Range
1	1 to 8
2	2 to 9
3	3 to 10
4	4 to 11
5	5 to 12
6	6 to 13
7	7 to 14
8	8 to 15
9	9 to 16

EXPLANATION OF RESISTANCE LEVEL

The difficulty level table shows the resistance level range at each difficulty level. Since some workouts have predetermined profiles, a resistance level range had to be created. This allows the user to set a difficulty level of 1 - 9, which will adjust the entire workouts intensity level.

STARTING A WORKOUT

After accepting a difficulty level, press START to begin the workout.

USING WORKOUTS IN PROGRESS

The exercise bike MANUAL program features 16 resistance levels, with “1” being the easiest and “16” being the most difficult. The exercise bike RANDOM, SLOPE, INTERVAL, PEAK, and CHALLENGE programs feature 9 difficulty levels, with “1” being the easiest and “9” being the most difficult. While a workout is in progress, it is possible to change the level of the overall workout. To do so, simply press the UP or DOWN arrow keys repeatedly until the DATA DISPLAY window shows the desired level. That change remains in effect for the entire workout or until the level is changed again.

NOTE: *The exercise bike features speed-dependent braking resistance. For a set resistance level on the monitor, the resistance increases with the user’s speed. The computer makes no adjustments to maintain the resistance level based on the user’s speed.*

PAUSING A WORKOUT

To pause a workout-in-progress, press the STOP key, or simply stop pedaling for 25 seconds. A workout can remain in pause mode for a maximum duration of five minutes. If a paused workout is not resumed before the five-minute pause duration ends, the console shuts down, and the paused workout information is lost. To resume a paused workout, press the START key or simply begin pedaling again.

RESETTING A WORKOUT

To reset a workout, press the STOP key, and hold it for three seconds. This deletes the current workout and makes it possible to set up a new workout.

REVIEWING A COMPLETED WORKOUT

When a workout reaches the end of its duration, the console emits four consecutive beeps. At this point, it is possible to review summary data for the completed workout, including total calories burned and distance traveled, by pressing the SCROLL key and reading the results in the DATA WINDOWS. Afterward, press the STOP key to return to the workout-select mode.

USING HEART RATE MONITORING TO MAXIMIZE WORKOUT BENEFITS

Research shows that keeping the heart rate within a certain range while exercising promotes muscular and cardiovascular conditioning for maximum health benefits. This range is between 60 percent and 85 percent of a given user's theoretical maximum heart rate. The maximum rate varies by age. To calculate it, subtract the user's age from the number 220.

For example, the theoretical maximum heart rate for a 35-year-old user would be 185 beats per minute (bpm) because $220 - 35 = 185$. Therefore, the optimal heart rate range or zone for a 35-year-old user would be between 111 bpm ($185 \times .60$) and 157 bpm ($185 \times .85$).

NOTE: *Consulting a fitness trainer is recommended for defining specific fitness goals and designing a workout program.*

To monitor heart rate during a workout, simply grasp the contact heart rate hand pulse sensors and view heart rate on the lower window of the console..

SWITCHING THE CONSOLE DISPLAY TO METRIC UNITS

By default, the bike's console displays the workout statistic of distance in English units. It is possible to switch to metric units. When the console is shut down, remove the four screws that attach the console to the console support assembly column. Carefully turn the console upside down and flip the "English/Metric" switch that appears in the back of the console to the "Metric" setting. Re-attach the console to the support assembly column. Restart the bike.

3.3 WORKOUT DESCRIPTIONS

INTERVAL

PURPOSE OF INTERVAL WORKOUT

Combines alternating hills and valleys of high and low resistance levels. Raising and lowering the heart rate in this manner is proven to efficiently promote fat burn and cardiovascular endurance

EXPLANATION OF TIME SEGMENTS

The workout has 16 total time segments, although the workout profile window can only display 8 segments at a time. The workout profile begins by displaying the first half of the workout, or 1 - 8 time segments. Once the eighth time segment is completed, the final 9 - 16 segments will be displayed. The current workout time segment will blink to show the active interval.

EXPLANATION OF SEGMENT DIFFICULTY LEVEL

The segment difficulty level is predetermined and will always be displayed as shown below.

EXPLANATION OF OVERALL WORKOUT DIFFICULTY LEVEL

During a workout, the overall workout difficulty level can be adjusted. There are 1 - 9 program difficulty levels and each has a corresponding resistance level range. See difficulty level table for reference. When the overall difficulty level is adjusted, there will be no visual change to the workout profile display.

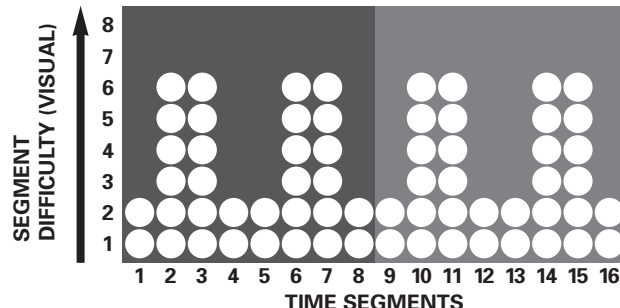

RANDOM

PURPOSE OF RANDOM WORKOUT

Provides a completely random workout profile of hills and valleys every time the user selects this workout. Endless variety reduces boredom.

EXPLANATION OF TIME SEGMENTS

The workout has 16 total time segments, although the workout profile window can only display 8 segments at a time. The workout profile begins by displaying the first half of the workout, or 1 - 8 time segments. Once the eighth time segment is completed, the final 9 - 16 segments will be displayed. The current workout time segment will blink to show the active interval.

EXPLANATION OF SEGMENT DIFFICULTY LEVEL

The segment difficulty level is predetermined and will always be displayed as shown below.

EXPLANATION OF OVERALL WORKOUT DIFFICULTY LEVEL

During a workout, the overall workout difficulty level can be adjusted. There are 1 - 9 program difficulty levels and each has a corresponding resistance level range. See difficulty level table for reference. When the overall difficulty level is adjusted, there will be no visual change to the workout profile display.

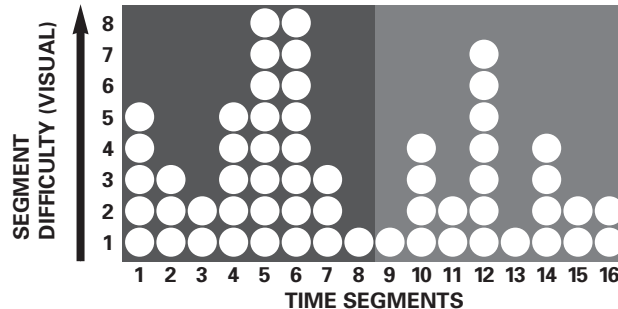

MANUAL

PURPOSE OF MANUAL WORKOUT

Allows the user to be in complete control of the resistance level. The level directly corresponds with the braking system. So if the user sets the level to 9, then the braking resistance is set to 9.

EXPLANATION OF TIME SEGMENTS

The workout has 20 total time segments displayed in the shape of a racetrack. The first time segment is located in the lower left corner of the racetrack. The current time segment will blink to help display the amount of time left in the workout.

EXPLANATION OF RESISTANCE LEVEL

Manual is the only workout where the levels are the actual resistance levels of the eddy current brake. The resistance level is displayed in the first column. There are 1 - 16 resistance levels to choose from. Each LED light in the column represents 2 levels. The below resistance level column is either at level 7 or 8. The resistance can be adjusted from 1 - 16 at any time during the workout.

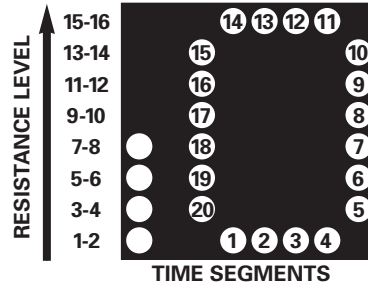

PEAK

PURPOSE OF PEAK WORKOUT

Maintains a constant resistance level throughout the workout. Intended to burn fat.

EXPLANATION OF TIME SEGMENTS

The workout has 16 total time segments, although the workout profile window can only display 8 segments at a time. The workout profile begins by displaying the first half of the workout, or 1 - 8 time segments. Once the eighth time segment is completed, the final 9 - 16 segments will be displayed. The current workout time segment will blink to show the active interval.

EXPLANATION OF SEGMENT DIFFICULTY LEVEL

The segment difficulty level is predetermined and will always be displayed as shown below.

EXPLANATION OF OVERALL WORKOUT DIFFICULTY LEVEL

During a workout, the overall workout difficulty level can be adjusted. There are 1 - 9 program difficulty levels and each has a corresponding resistance level range. See difficulty level table for reference. When the overall difficulty level is adjusted, there will be no visual change to the workout profile display.

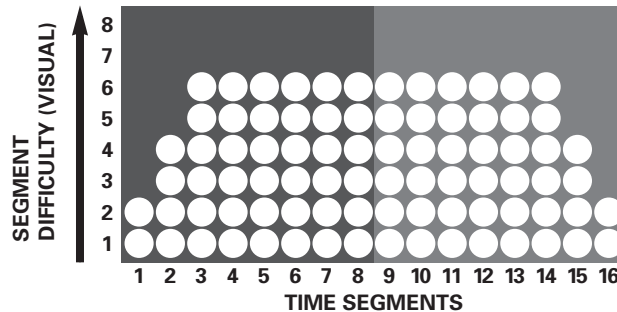

SLOPE

PURPOSE OF SLOPE WORKOUT

Gradually increases resistance so user is less aware of the physical demand. Helps user slowly build-up to higher resistance levels and improve cardiovascular endurance.

EXPLANATION OF TIME SEGMENTS

The workout has 16 total time segments, although the workout profile window can only display 8 segments at a time. The workout profile begins by displaying the first half of the workout, or 1 - 8 time segments. Once the eighth time segment is completed, the final 9 - 16 segments will be displayed. The current workout time segment will blink to show the active interval.

EXPLANATION OF SEGMENT DIFFICULTY LEVEL

The segment difficulty level is predetermined and will always be displayed as shown below.

EXPLANATION OF OVERALL WORKOUT DIFFICULTY LEVEL

During a workout, the overall workout difficulty level can be adjusted. There are 1 - 9 program difficulty levels and each has a corresponding resistance level range. See difficulty level table for reference. When the overall difficulty level is adjusted, there will be no visual change to the workout profile display.

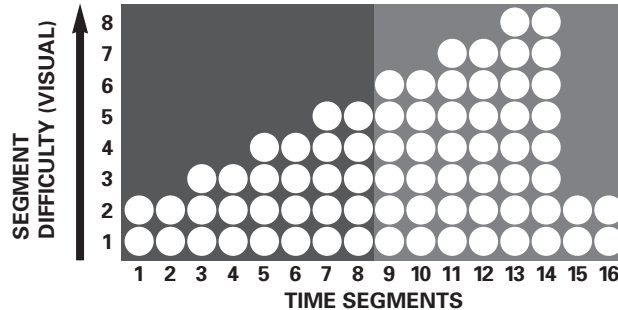

CHALLENGE

PURPOSE OF CHALLENGE WORKOUT

Maintains a high resistance level throughout the workout. Challenges the user to a high intensity workout that promotes cardiovascular endurance.

EXPLANATION OF TIME SEGMENTS

The workout has 16 total time segments, although the workout profile window can only display 8 segments at a time. The workout profile begins by displaying the first half of the workout, or 1 - 8 time segments. Once the eighth time segment is completed, the final 9 - 16 segments will be displayed. The current workout time segment will blink to show the active interval.

EXPLANATION OF SEGMENT DIFFICULTY LEVEL

The segment difficulty level is predetermined and will always be displayed as shown below.

EXPLANATION OF OVERALL WORKOUT DIFFICULTY LEVEL

During a workout, the overall workout difficulty level can be adjusted. There are 1 - 9 program difficulty levels and each has a corresponding resistance level range. See difficulty level table for reference. When the overall difficulty level is adjusted, there will be no visual change to the workout profile display.

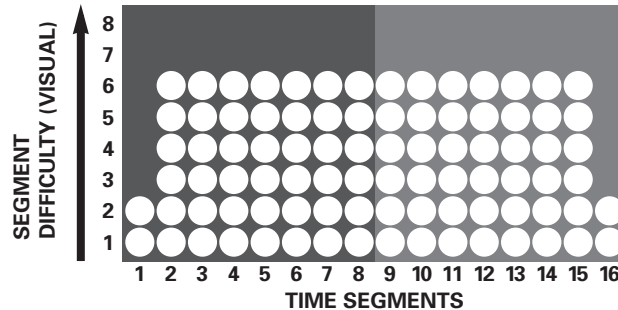

3.4 USING THE WORKOUTS (CHART)

The following charts will help you set up and begin the various workout programs. First, select a workout using the specific workout key. Then, use the Arrows to enter data as prompted. The display will prompt for any additional information that may be needed for the new workout.

WORKOUT SELECTIONS

MANUAL

Enter time
Enter level
Begin workout

RANDOM

Enter time
Enter level
Begin workout

INTERVAL

Enter time
Enter level
Begin workout

PEAK

Enter time
Enter level
Begin workout

SLOPE

Enter time
Enter level
Begin workout

CHALLENGE

Enter time
Enter level
Begin workout

4 SERVICE AND TECHNICAL DATA

4.1 PREVENTATIVE MAINTENANCE TIPS

The exercise bike is backed by engineering excellence and is one of the most rugged and trouble-free pieces of exercise equipment on the market today. The manufacturer's products have proven to be durable in health clubs, colleges, military facilities, and other locations the world over. This same technology, engineering expertise, and reliability have gone into the exercise bike.

NOTE: *The safety of the equipment can be maintained only if the equipment is examined regularly for damage or wear. If maintenance is required, keep the equipment out of use until defective parts are repaired or replaced. Pay special attention to parts that are subject to wear as outlined in the Preventive Maintenance Schedule.*

The following preventive maintenance tips will keep the exercise bike operating at peak performance:

- Locate the exercise bike in a cool, dry place.
- Clean the top surface of the pedals regularly.
- Keep the display console free of fingerprints and salt build-up caused by sweat.
- Use a **100% cotton cloth**, lightly moistened with water and a mild liquid cleaning product, to clean the exercise bike. Other fabrics, including paper towels, may scratch the surface. **Do not use ammonia or acid-based cleaners.**
- Long fingernails may damage or scratch the surface of the console; use the pad of the finger to press the selection buttons on the console.
- Clean the housing thoroughly on a regular basis.

NOTE: *A non-abrasive cleaner and soft cotton cloth are strongly recommended for cleaning the exterior of the unit. At no time should cleaner be applied directly to any part of the equipment; apply the non-abrasive cleaner on a soft cloth, and then wipe the unit.*

4.2 PREVENTATIVE MAINTENANCE SCHEDULE

Follow the schedule below to ensure proper operation of the product.

ITEM	WEEKLY	MONTHLY	BI-ANNUALLY	ANNUALLY
<i>Display Console</i>	C	I		
<i>Console Mounting Bolts</i>			I	
<i>Accessory Tray</i>	C	I		
<i>Frame</i>	C			I
<i>Plastic Covers</i>	C	I		
<i>Pedals and Straps</i>	C	I		
KEY: C=Clean; I=Inspect				

4.3 TROUBLESHOOTING THE HAND PULSE SENSORS

If the heart rate reading is erratic or missing, do the following:

- Apply hands to both sensors, one in each hand.
- Grasp the sensors firmly.
- Apply constant pressure around the sensors. Follow the schedule below to ensure proper operation of the product.

4.4 TROUBLESHOOTING THE EXERCISE BIKE

Problem	Solution
I hear a clicking noise while I'm pedaling.	Use the wrench that was included with the bike to ensure the pedals are assembled as tight as possible.
My console does not turn on (light up).	Check to make sure the power supply cord is fully plugged into the rear of product and into the wall.
My console has strange characters on the display or my console seems like it is frozen.	Unplug the bike from the wall or rear of the plastic shrouding and then plug the bike back in to reset the console.
The seat wobbles on my recumbent bike.	<p>The seat carriage can be adjusted if it is too tight and does not slide freely or if it is too loose and rocks excessively.</p> <p>To adjust the fit of the carriage when there is excessive rocking use a wrench to loosen the jam nut on either side of the seat carriage. With another wrench, tighten the adjustment roller on the inside of the carriage until is it snug, but do not over-tighten. Then, while holding the roller in place, tighten the lock nut. Repeat the procedure for the other side of the carriage.</p> <p>To adjust the fit of the carriage when it does not slide freely, use a wrench to loosen the jam nut on either side of the seat carriage. With another wrench, loosen the adjustment roller on the inside of the carriage until it can move freely, but do not excessively loosen. Then, while holding the roller in place, tighten the lock nut. Repeat the procedure for the other side of the seat carriage.</p>

Problem

My console only lets me choose 1-9 resistance levels when I was told there are 16 resistance levels on this bike

Solution

Random, Slope, Peak, Challenge, and Interval programs all use 1-9 difficulty levels as opposed to resistance levels. This is because the program has a predetermined profile. In order to maintain this profile a range of resistance levels needed to be assigned to a smaller amount of difficult levels (1-9). So for example when you change the difficulty level from 8 to 9 the resistance level range changes from 8-15 to 9-16. This allows the lowest point in the profile to be at resistance level 9 and the highest point in the program profile to be at resistance level 16.

The manual workout program uses 1-16 resistance levels as opposed to difficulty levels. This is because there is no predetermined profile. The program is designed to put the user in complete control of the actual resistance.

4.5 HOW TO OBTAIN PRODUCT SERVICE

1. Verify the symptom and review the operating instructions. The problem may be unfamiliarity with the product and its features and workouts.
2. Locate and document the serial number of the unit. The serial number plate is located on the front stabilizer, below the shroud.
3. Contact Customer Support Services via the Web at: www.lifefitness.com, or call the nearest Customer Support Services group:

For Product Service within
the United States and Canada:

Telephone: (+1) 847.451.0036

FAX: (+1) 847.288.3702

Toll-free telephone: 800.351.3737

For Product Service
Internationally:

Life Fitness Europe GmbH

Telephone: (+49) 089.317.751.66

FAX: (+49) 089.317.751.38

Life Fitness (UK) LTD

Telephone: (+44) 1353.665507

FAX: (+44) 1353.666018

Life Fitness Atlantic BV

Life Fitness Benelux

Telephone: +31 (0) 180 64 66 66

FAX: +31 (0) 180 64 66 99

Life Fitness Italia S.R.L.

Telephone: (+39) 0472.835.470

FAX: (+39) 0472.833.150

Toll-free telephone: 800.438836

Life Fitness Vertriebs GmbH

Telephone: (+43) 1615.7198

FAX: (+43) 1615.7198.20

Life Fitness Asia Pacific Ltd

Telephone: (+852) 2891.6677

FAX: (+852) 2575.6001

*Life Fitness Latin America
and Caribbean*

Telephone: (+1) 847.288.3964

FAX: (+1) 847 288.3886

Life Fitness Brazil

Telephone: (+55) 11.7295.2217

FAX: (+55) 11.7295.2218

Life Fitness Japan

Telephone: (+81) 3.3359.4306

FAX: (+81) 3.3359.4307

Life Fitness Iberia

Telephone : (+34) 93 672 4660

FAX : (+34) 93 672 4670

5 WARRANTY INFORMATION

WHAT IS COVERED:

This Life Fitness consumer product ("Product") is warranted to be free of all defects in material and workmanship.

WHO IS COVERED:

The original purchaser or any person receiving a newly purchased Product as a gift from the original purchaser.

HOW LONG IS IT COVERED:

Residential: All electrical and mechanical components and labor are covered, after the date of purchase, as listed on the chart at the end of this section.

Non-Residential: Warranty void (this Product is intended for residential use only).

WHO PAYS SHIPPING & INSURANCE FOR SERVICE:

If the Product or any warranted part must be returned to a service facility for repairs, Life Fitness will pay all shipping and insurance charges during the warranty period (within the United States only). The purchaser is responsible for shipping and insurance charges after the warranty has expired.

WHAT WE WILL DO TO CORRECT COVERED DEFECTS:

We will ship to you any new or rebuilt replacement part or component, or, at our option, replace the Product. Such replacement parts are warranted for the remaining portion of the original warranty period.

WHAT IS NOT COVERED:

Any failures or damage caused by unauthorized service, misuse, accident, negligence, improper assembly or installation, debris resulting from any construction activities in the Product's environment, rust or corrosion as a result of the Product's location, alterations or modifications without our written authorization or by failure on your part to use, operate and maintain the Product as set out in your User Manual ("Manual"). All terms of this warranty are void if this Product is moved beyond the continental borders of the United States of America (excluding Alaska, Hawaii and Canada) and are then subject to the terms provided by that country's local authorized Life Fitness Representative.

WHAT YOU MUST DO:

Retain proof of purchase (our receipt of the attached registration card assures registration of purchase information but is not required); use, operate and maintain the Product as specified in the Manual; notify Customer Service of any defect within 10 days after discovery of the defect; if instructed, return any defective part for replacement or, if necessary, the entire Product for repair. Life Fitness reserves the right to decide whether or not a product is to be returned for repair.

USER MANUAL:

It is VERY IMPORTANT THAT YOU READ THE MANUAL before operating the Product. Remember to perform the periodic maintenance requirements specified in the Manual to assure proper operation and your continued satisfaction.

PRODUCT REGISTRATION:

Register online at www.lifefitness.com/registration. Our receipt assures that your name, address and date of purchase are on file as a registered owner of the Product. Failure to return the card will not affect your rights under this warranty. Being a registered owner assures coverage in the event you lose your proof of purchase. Please retain your proof of purchase, such as your bill of sale or receipt.

HOW TO GET PARTS & SERVICE:

Simply call Customer Service at 1-800-351-3737 or (+1) 847-288-3300, Monday through Friday from 8:00 a.m. to 5:00 p.m. Central Standard Time, and tell them your name, address and the serial number of your Product (consoles and frames may have separate serial numbers). They will tell you how to get a replacement part, or, if necessary, arrange for service where your Product is located.

EXCLUSIVE WARRANTY:

THIS LIMITED WARRANTY IS IN LIEU OF ALL OTHER WARRANTIES OF ANY KIND EITHER EXPRESSED OR IMPLIED, INCLUDING BUT NOT LIMITED TO THE IMPLIED WARRANTIES OF MERCHANTABILITY AND FITNESS FOR A PARTICULAR PURPOSE, AND ALL OTHER OBLIGATIONS OR LIABILITIES ON OUR PART. We neither assume nor authorize any person to assure for us any other obligation or liability concerning the sale of this Product. Under no circumstances shall we be liable under this warranty, or otherwise, of any damage to any person or property, including any lost profits or lost savings, for any special, indirect, secondary, incidental or consequential damages of any nature arising out of the use of or inability to use this Product. Some states do not allow the exclusion or limitation of implied warranties or of liability for incidental or consequential damages, so the above limitations or exclusions may not apply to you. Warranties may vary outside the U.S. Contact Life Fitness for details.

CHANGES IN WARRANTY NOT AUTHORIZED:

No one is authorized to change, modify or extend the terms of this limited warranty.

EFFECT OF U.S. STATE LAWS:

This warranty gives you specific legal rights and you may have other rights which vary from state to state.

MODEL	LIFETIME	5 YEARS	3 YEARS	1 YEAR
C15	Frame	N/A	Electrical Parts & Mechanical Parts	Labor
R15	Frame	N/A	Electrical Parts & Mechanical Parts	Labor

6 SPECIFICATIONS

6.1 UPRIGHT AND RECUMBENT EXERCISE BIKE SPECIFICATIONS

Designed use: Home
Maximum user weight: 300 pounds / 136 kilograms

CONSOLE:

Displays: DATA DISPLAYS with time, RPM, distance, calories, level. and heart rate
DOT MATRIX WINDOW indicating workout profile
Summaries: Total Distance and Total Calories Burned

WORKOUTS:

Quick Start Manual Mode, Interval, Random, Manual, Peak, Slope, Challenge
Resistance levels: 16
Pedal size 4.5 inches / 11.5 centimeters
Drive type: Poly-V belt-drive
Power requirements: 120V in United States
220V in Europe
240+V in Australia
Color: Pewter Metal
Charcoal Plastic Shrouds
Stone Plastic Accents

C15 ASSEMBLED DIMENSIONS:

Length	41 inches / 104 centimeters
Width	23.5 inches / 60 centimeters
Height	56 inches / 142 centimeters
Weight	116 pounds / 52.6 kilograms

C15 SHIPPING DIMENSIONS:

Length	44.88 inches / 114 centimeters
Width	17.91 inches / 45.5 centimeters
Height	29.92 inches / 76 centimeters
Weight	132 pounds / 59.9 kilograms

R15 ASSEMBLED DIMENSIONS:

Length	56.5 inches / 143.5 centimeters
Width	25.75 inches / 70.5 centimeters
Height	50 inches / 127 centimeters
Weight	146 pounds / 66.2 kilograms

R15 SHIPPING DIMENSIONS:

Length	59.84 inches / 152 centimeters
Width	17.91 inches / 45.5 centimeters
Height	29.92 inches / 76 centimeters
Weight	166 pounds / 75.3 kilograms

- **Heart Rate**
 - **RPM (Revolutions Per Minute):** The pedaling speed or rate
 - **Distance:** The total distance traveled
 - **Calories:** The number of calories burned
 - **Level:** The level of a workout-in-progress
- F** **WORKOUT LED INDICATORS:** One set of LEDs is matched to the bike's set of workout options. During a workout setup, each time the user presses an ARROW key to view another workout option, one of these LEDs lights up to indicate that the corresponding workout is the currently displayed option. During a workout-in-progress, the LED corresponding to that workout remains lit up.
- Another set of LEDs is matched to a set of workout statistics. See the DATA WINDOWS description above.
- G** **DOT MATRIX DISPLAY:** This window displays a workout's profile, which consists of columns of light that represent the intensity of each interval.



Life Fitness offers a full line of premier fitness equipment for the home.

TOTAL-BODY ELLIPTICAL CROSS-TRAINERS | TREADMILLS | LIFECYCLE® EXERCISE BIKES
STAIRCLIMBERS | GYM SYSTEMS

5100 N. RIVER ROAD, SCHILLER PARK, ILLINOIS 60176
LIFEFITNESS.COM